

# MORANE-SAILNIER

# BULLET

MORE ASSEMBLY DETAILS AT:  
[www.fiddlersgreen.net](http://www.fiddlersgreen.net)

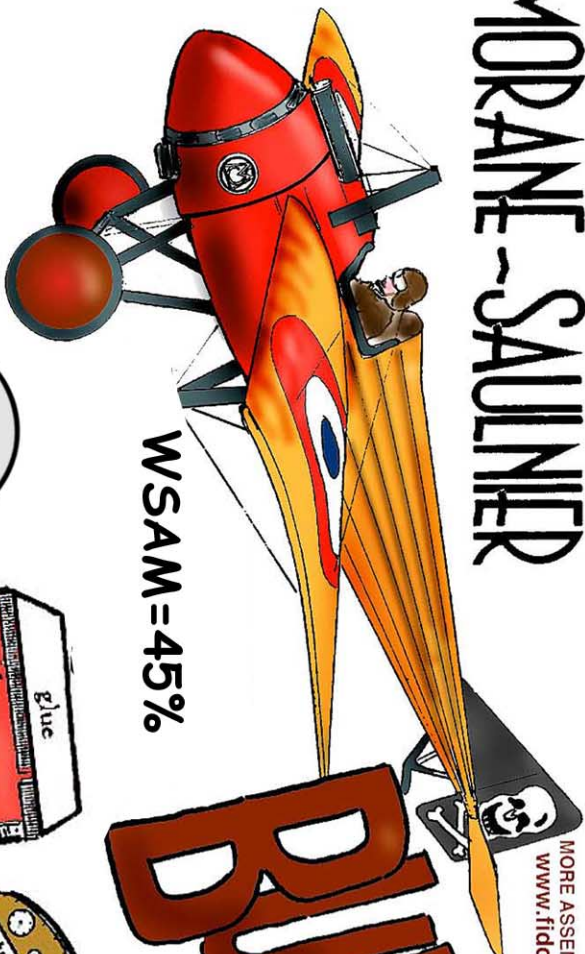

WSAM = 45%



PROPELLER

SHEET ONE



SPINNER DISK

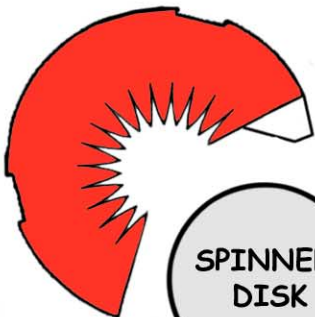

ROTARY ENGINE  
(optional)

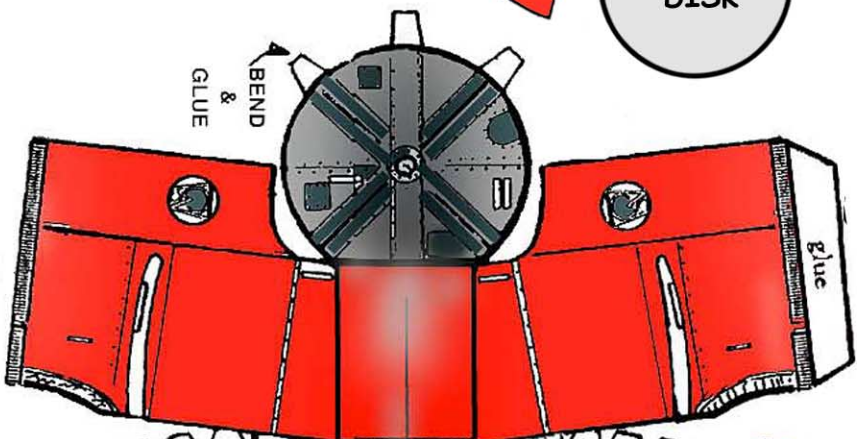
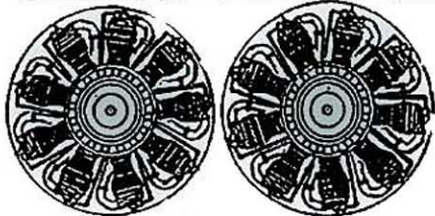

instrument panel

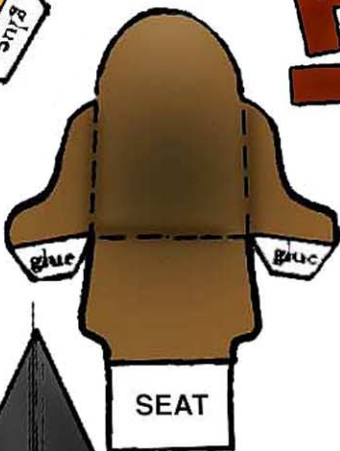

SEAT

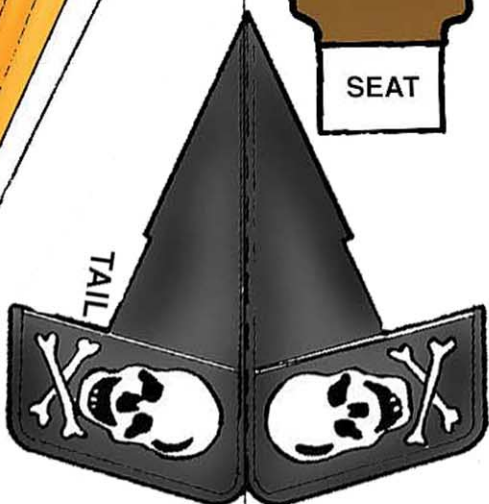

TAIL

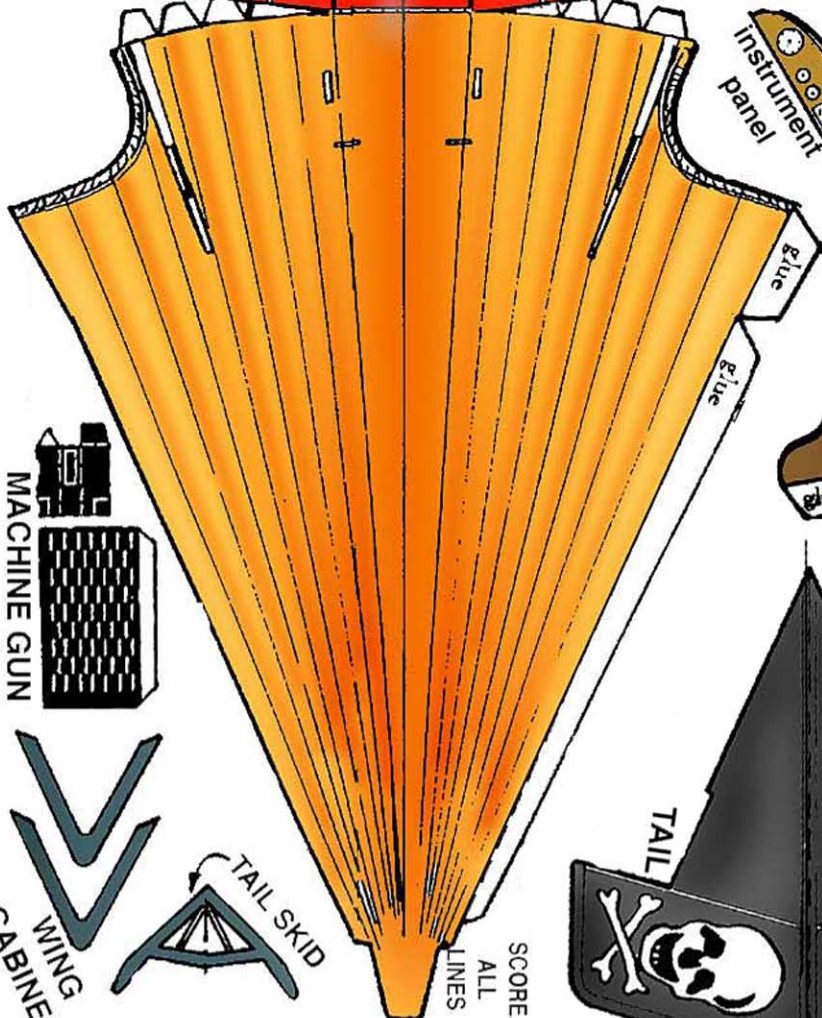

SCORE ALL LINES



MACHINE GUN



WING CABINES

TAIL SKID

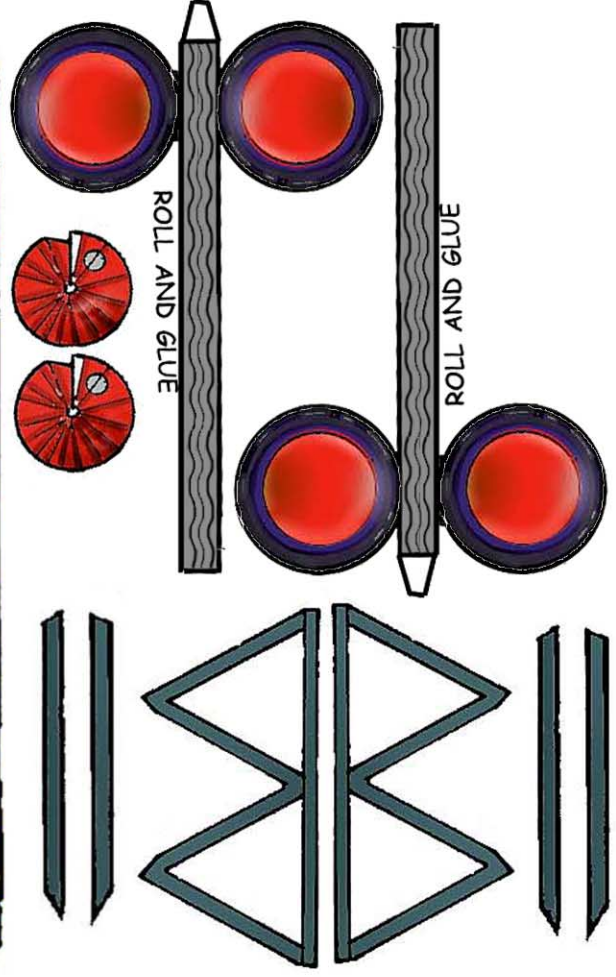
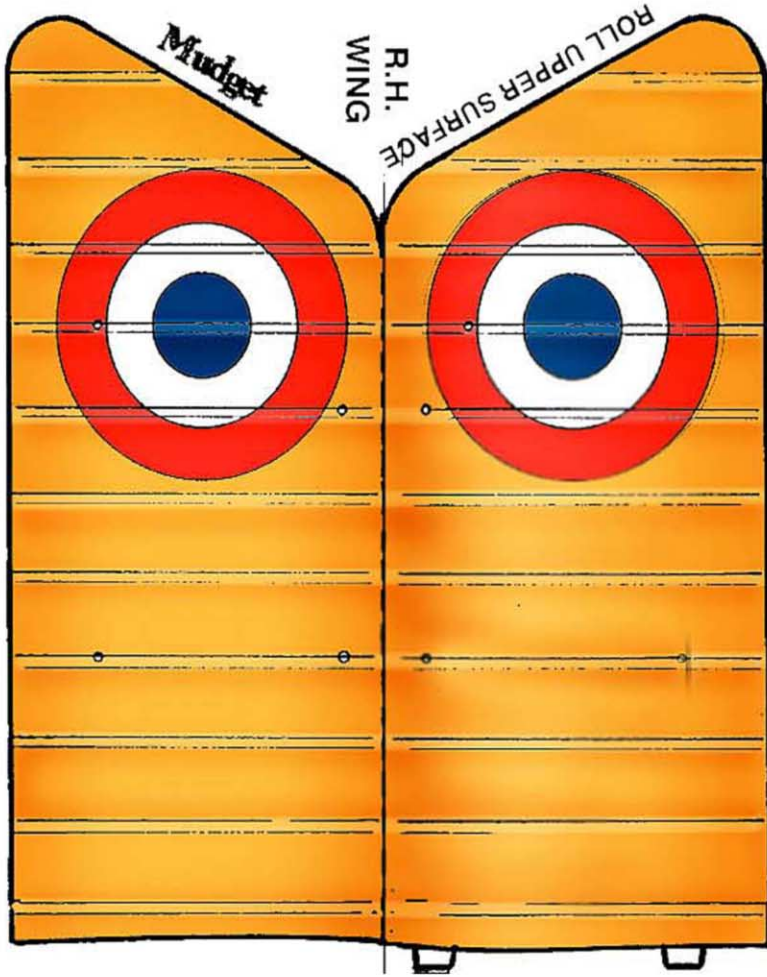

READ MORE ABOUT  
THE MS BULLET AT  
OUR COMPANION WEB SITE:  
[WWW.FIDDLERSGREEN.NET](http://WWW.FIDDLERSGREEN.NET)

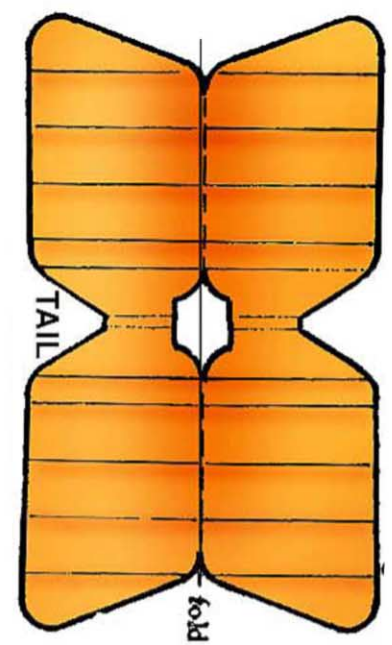
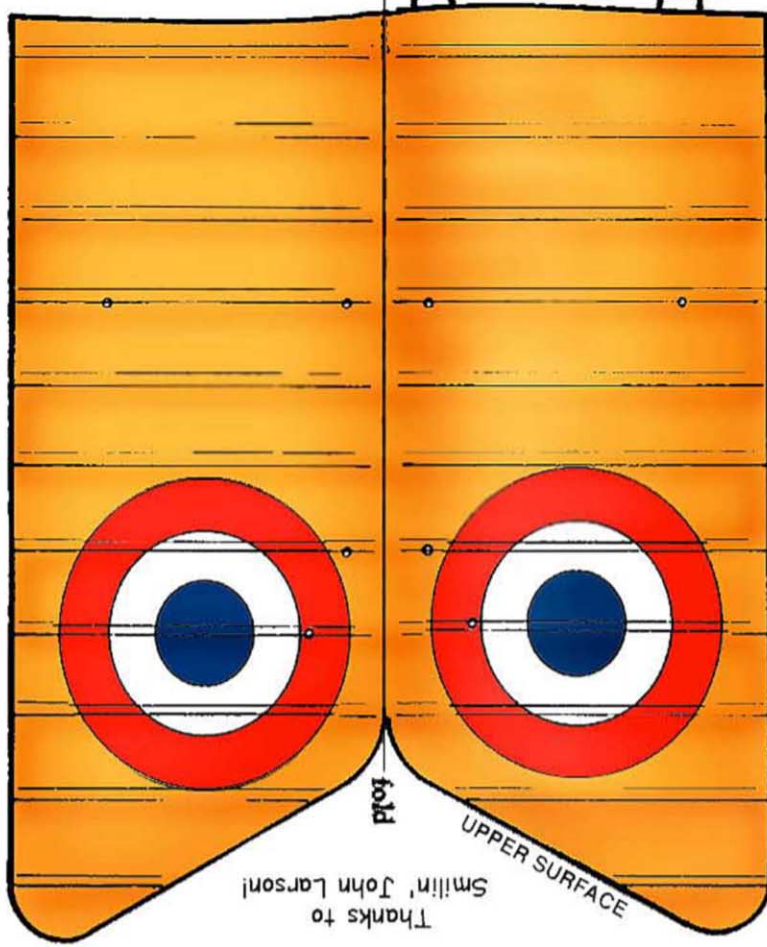

**MS BULLET**  
SHEET TWO

# Morane-Saulnier N 'BULLET'

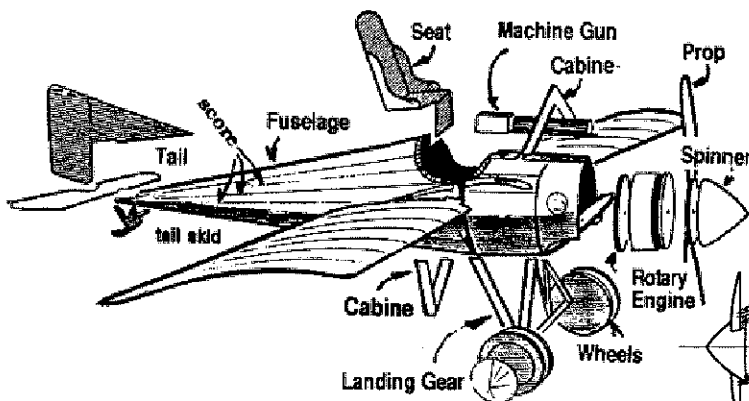

The first fixed forward-firing machine-gun to be fired in anger from a plane in flight, early in 1915, was installed on a Morane-Saulnier L. The gun, an 8-mm (.315-in) Hotchkiss, was installed just behind the engine cowling, and was fired successfully through the propeller disk with the aid of a simple mechanism: two steel plates fastened to the rear of the blades on the line of fire protected the propeller by deflecting bullets that would have struck its blades. Rudimentary as this deflector plate system may have been, it made the Morane-Saulnier L the first real 'fighter' plane in the history of aviation. The user of this deflector, French pilot Roland Garros, shot down five enemy planes in the first three weeks of April 1915.

The Morane-Saulnier L was the first in a long line of monoplane fighters produced by Robert and Léon Morane and their partner Raymond Saulnier. The design was developed in 1913 and when war broke out, many Type Ls were ordered for reconnaissance work. This high-performance plane was a better aircraft than the contemporary Aviatik and Albatros two-seaters. The crews carried small arms, such as pistols and carbines, to combat enemy planes, and several planes were downed in this primitive system of air combat. One of many pilots who had their baptism of fire in a Type L monoplane was the then Corporal Guynemer, who was to become one of the great aces of the war. He shot down a German two-seater on July 19, 1915, with a machine-gun.

The Morane-Saulnier L, of which about 600 were built, was followed in 1914 by the Types LA and P, larger, more powerful and better armed. The Type P was the more popular of the two. It did reconnaissance duty in the French air force, and was also used by the British until 1916-17: 595 of them were built.

The Morane-Saulnier N, which also appeared in 1914, was very different from its predecessors. It was a plane of very advanced design, highly streamlined, very fast and extremely manoeuvrable. Nevertheless, it was not as successful as other Morane-Saulnier models, and only 49 were built.

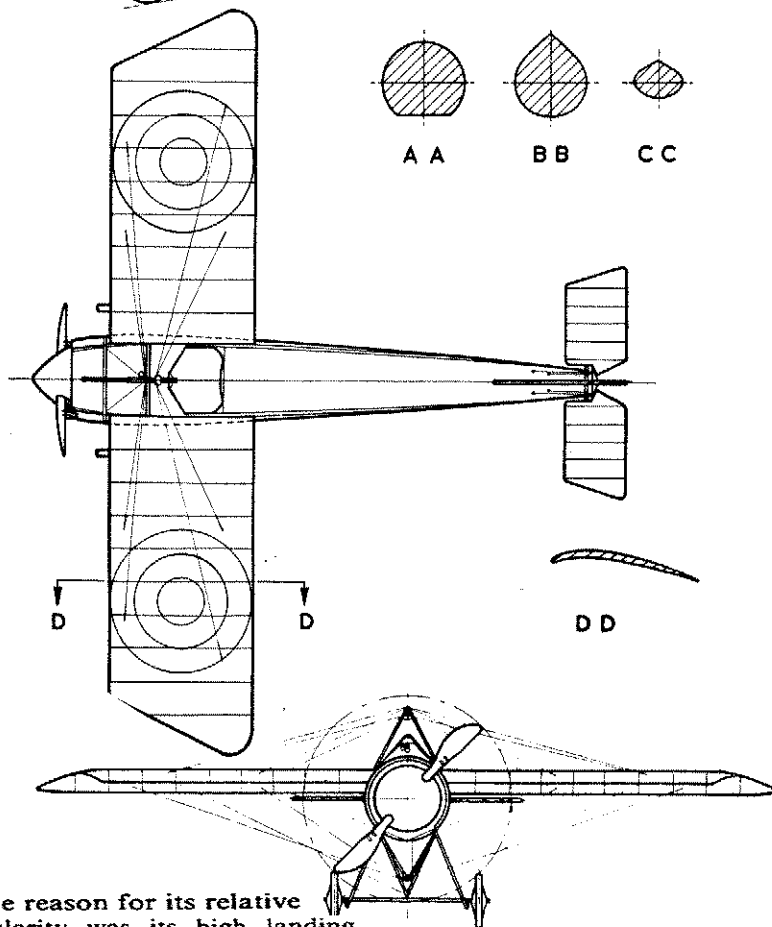
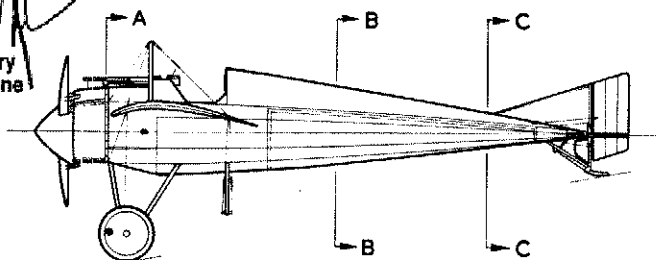
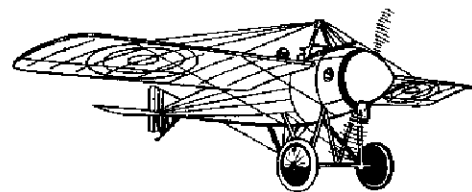

One reason for its relative unpopularity was its high landing speed and its delicate handling characteristics. It took a really expert pilot to fly it for the French air force, with another small batch going to the Royal Flying Corps (enough for four squadrons) and an even smaller batch to the Imperial Russian Air Service (enough for just one squadron).

Type: Fighter  
 Year: 1914  
 Engine: Le Rhône 9C 9-cylinder air-cooled rotary, 80 hp  
 Wingspan: 26 ft 8.5 in (8.15 m)  
 Length: 19 ft 1.5 in (5.83 m)  
 Height: 7 ft 4.5 in (2.25 m)  
 Weight: 976 lbs (444 kg)  
 Maximum speed: 90 mph (144 kph)  
 Ceiling: 13,123 ft (4,000 m)  
 Endurance: 1 hr 30 mins  
 Armament: 1 machine-gun  
 Crew: 1

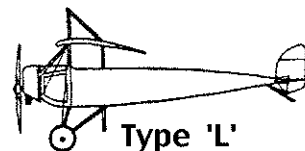

Type 'L'

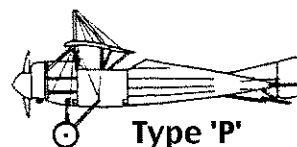

Type 'P'

Lots more information at [www.fiddlersgreen.net](http://www.fiddlersgreen.net)

# Are you being ripped off?

With the purchase of any Fiddlers Green CD rom, you receive 12 months of additional FREE models. When you buy (at a VERY reasonable price!) even ONE Fiddlersgreen model you get personal and caring follow-up support. You can certainly understand that we need to receive fair compensation for our past work to continue creating new designs. Thank you

IF you have been charged for any Fiddlers Green™ model CD ROM(s) and have NOT been offered the Magic Electronic Key feature© which entitles you to free new Fiddlers Green models for the ENTIRE year following your purchase.. the electronic files probably have been pirated and you have most probably been ripped off!

Fiddlers Green CD ROMs of Fiddlers Green model files must be registered DIRECTLY with Fiddlers Green. If you have purchased this electronic file or CD rom from a reseller who is unable to offer you directly, the free follow up models, please email our Legal Dept immediately with as much information as possible regarding how and where you bought the pirated product. There is a reward waiting.

---

## Contents

- \* FIDDLERS GREEN Copyright & Fair Use
- \* Warranty And Disclaimer
- \* **How to contact us**

---

## Copyright And Fair Use

All images and software are copyrighted. Permission is granted ONLY for non-commercial personal use. They may not be duplicate in any form, including electronic, mechanical or printed, for sale. All rights are reserved and duplication by any means, including, but not limited to, methods of printing, electronic storage and disk copies, is prohibited without permission. Payment of the fee for the digital Fiddlers Green product entitles you to use the program on a single computer; it does not transfer ANY title or ownership. If you wish to use artwork, an instructional sheet or model file for other than for your own personal use, ie: for a club contest or school program, PLEASE contact me for written permission first. NOTE: You , as the registered owner, are permitted to take this disk to any copy service (kinkos, etc) and get printouts of model files for **your own use**.

Only the digital SAMPLE MODELS and/or electronic instructions may be freely distributed, provided this file and the copyright notice remains intact. You may NOT duplicate, sell or give away, in any form, any copy of the CD ROM version. Only the copyright owner, **WWW.FIDDLERSGREEN.NET** can give permission for copies to be made. These free sample Files **MUST NOT BE SUBJECT TO A CHARGE IN ANY FORM.**

Web masters and site owners please contact **legal@fiddlersgreen.net** for permission prior to making or distributing any copy(s) of model files or instruction sheets. You are expected to honor this Personal-Use Copyright Notice.

THE PROGRAMS AND INFORMATION ARE PROVIDED "AS IS". NO OTHER WARRANTIES OF ANY KIND, EXPRESS OR IMPLIED, ARE MADE AS TO IT OR ANY MEDIUM IT MAY BE ON. FIDDLERS GREEN and/or Chip Fyn DISCLAIM ALL OTHER WARRANTIES, EITHER EXPRESSED OR IMPLIED, INCLUDING BUT NOT LIMITED TO IMPLIED WARRANTIES OF MERCHANTABILITY AND FITNESS FOR A PARTICULAR PURPOSE OR NON-INFRINGEMENT, WITH RESPECT TO THE SOFTWARE AND THE ACCOMPANYING WRITTEN OR GRAPHIC MATERIALS. FIDDLERS GREEN and/or Chip Fyn ASSUMES NO RESPONSIBILITY FOR ERRORS OR OMISSIONS IN THIS PUBLICATION OR OTHER DOCUMENTS WHICH ARE REFERENCED BY OR LINKED TO THIS PUBLICATION.

---

legal@fiddlersgreen.net  
**FIDDLERS GREEN LEGAL DEPT**

Web Site: <http://www.fiddlersgreen.net>

---

Copyright © 1998 Fiddlers Green. All rights reserved.